

Ultimus™ I, II and III

Dispensing Workstation

User's Guide



Ultimus I
#7017041

Ultimus II
#7002003

Ultimus III
#7017068

IMPORTANT!
Save this Sheet.

Forward to
Maintenance or
Tool Crib Supervisors

Electronic pdf files of
EFD manuals are also available
at www.nordsonefd.com

Nordson
EFD

Welcome to the Ultimius I, II and III, the most complete dispensing system on the market. This User's Guide will help you maximize the usefulness of your new workstation.

Please spend a few minutes to become familiar with the controls and features. Follow our recommended testing procedures. Review the helpful information we have included, which is based on more than 30 years of industrial dispensing experience.

Most questions you will have are answered in this guide. However, if you need assistance, please do not hesitate to contact Nordson EFD or your authorized Nordson EFD distributor.

In the USA, call 800.556.3484 between 8:30 a.m. and 5:30 p.m. Eastern time.

In Europe, call +44 (0) 1582 666334.

In Asia, call +86 (21) 3866 9006.

In all other areas, call your authorized EFD distributor or +1.401.431.7000.

The Nordson EFD Pledge

We pledge that you will be completely satisfied with our products. We endeavor to ensure that every Nordson EFD product is produced to our no-compromise quality standards.

If you feel that you are not receiving all the support you require, or if you have any questions or comments, I invite you to write or call me personally.

Our goal is to build not only the finest equipment and components, but also to build long-term customer relationships founded on superb quality, service, value and trust.

Jeff Pembroke, President

Safety 4

Getting Started 6

Specifications 7

Features and Controls 8-10

 Back Panel 11

Filling the Syringe Barrel 13

Vacuum Control 14

Syringe Barrel Loaders 15

Test Procedures 16

Memory 18

Menu Functions 20

Input/Output Connection 22

Schematic 23

Troubleshooting 24

Helpful Hints 25

Productivity Tools 26

Warranty Back Cover

IMPORTANT SAFETY INFORMATION

All Nordson EFD disposable components, including syringe barrels, cartridges, pistons, tip caps, end caps, and dispense tips, are precision engineered for one-time use. Attempting to clean and re-use components will compromise dispensing accuracy and may increase the risk of personal injury.

Always wear appropriate protective equipment and clothing suitable for your dispensing application.

Do not exceed maximum operating pressure of 100 psi (7.0kg/cm2).

Do not heat syringe barrels or cartridges to a temperature greater than 100°F (38°C).

Dispose of components according to local regulations after one-time use.

Do not clean components with strong solvents (e.g. MEK, Acetone, THF).

Cartridge retainer systems and barrel loaders should be cleaned with mild detergents only.

To prevent fluid waste, use Nordson EFD SmoothFlow™ pistons.

This manual is for the express and sole use of EFD dispenser purchasers and users, and no portion of it may be reproduced in any form.

Introduction

Read and follow these safety instructions. Task- and equipment-specific warnings, cautions and instructions are included in equipment documentation where appropriate.

Qualified Personnel

Equipment owners are responsible for making sure that EFD equipment is installed, operated and serviced by qualified personnel. Qualified personnel are those employees or contractors who are trained to safely perform their assigned tasks. They are familiar with all relevant safety rules and regulations, and are physically capable of performing their assigned tasks.

Intended Use

Use of EFD equipment in ways other than those described in the documentation supplied with the equipment may result in injury to persons or damage to property.

Some examples of unintended use of equipment include

- Using incompatible materials
- Making unauthorized modifications
- Removing or bypassing safety guards or interlocks
- Using incompatible or damaged parts
- Using unapproved auxiliary equipment
- Operating equipment in excess of maximum ratings

Regulations and Approvals

Make sure all equipment is rated and approved for the environment in which it is used. Any approvals obtained for EFD equipment will be voided if instructions for installation, operation and service are not followed.

Personal Safety

To prevent injury follow these instructions.

- Do not operate or service equipment unless you are qualified.
- Do not operate equipment unless safety guards, doors or covers are intact and automatic interlocks are operating properly. Do not bypass or disarm any safety devices.
- If you receive even a slight electrical shock, shut down all electrical or equipment immediately. Do not restart the equipment until the problem has been identified and corrected.
- Obtain and read Material Safety Data Sheets (MSDS) for all materials used. Follow the manufacturer's instructions for safe handling and use of materials, and use recommended personal protection devices.
- To prevent injury, be aware of less-obvious dangers in the workplace that often cannot be completely eliminated, such as hot surfaces, sharp edges, energized electrical circuits and moving parts that cannot be enclosed or otherwise guarded for practical reasons.
- This equipment is for indoor use only.
- Use only the power adapter provided with the unit. Contact EFD to purchase a replacement adapter.
- Always keep dispensing end of syringe barrel pointed away from your face and towards the work piece. Store the syringe barrel in an appropriate holder when not in use.
- Caution: Use EFD filter/muffler #7016875 or wear adequate ear protection when operating the vacuum in close proximity for a prolonged period of time.
- Caution: A pressure regulator of 0 to 100 psi is intended to be provided before connecting unit to the air supply.

Fire Safety

To avoid a fire or explosion, follow these instructions.

- Shut down all equipment immediately if you notice static sparking or arcing. Do not restart the equipment until the cause has been identified and corrected.
- Do not smoke, weld, grind or use open flames where flammable materials are being used or stored.
- Provide adequate ventilation to prevent dangerous concentrations of volatile particles or vapors. Refer to local codes or your material MSDS for guidance.
- Do not disconnect live electrical circuits when working with flammable materials. Shut off power at a disconnect switch first to prevent sparking.
- Know where emergency stop buttons, shutoff valves and fire extinguishers are located.
- Clean, maintain, test and repair equipment according to the instructions in your equipment documentation.
- Use only replacement parts that are designed for use with original equipment. Contact your EFD representative for parts information and advice.

Action in the Event of a Malfunction

If a system or any equipment in a system malfunctions, shut off the system immediately and perform the following steps:

- Disconnect and lock out system electrical power.
- Identify the reason for the malfunction and correct it before restarting the system.

Disposal

Dispose of equipment and materials used in operation and servicing according to local and national codes.

RoHS标准相关声明 (China RoHS Hazardous Material Declaration)

产品名称 Part Name	有害物质及元素 Toxic or Hazardous Substances and Elements					
	铅 Lead (Pb)	汞 Mercury (Hg)	镉 Cadmium (Cd)	六价铬 Hexavalent Chromium (Cr6)	多溴联苯 Polybrominated Biphenyls (PBB)	多溴联苯醚 Polybrominated Diphenyl Ethers (PBDE)
金属转接头 All Brass Fittings	X	0	0	0	0	0
<p>0: 表示该产品所含有的危险成分或有害物质含量依照EIP-A, EIP-B, EIP-C 的标准低于 SJ/T11363-2006 限定要求。 0: Indicates that this toxic or hazardous substance contained in all the homogeneous materials for this part, according to EIP-A, EIP-B, EIP-C is below the limit requirement in SJ/T11363-2006.</p> <p>X: 表示该产品所含有的危险成分或有害物质含量依照EIP-A, EIP-B, EIP-C 的标准高于 SJ/T11363-2006 限定要求。 X: Indicates that this toxic or hazardous substance contained in all the homogeneous materials for this part, according to EIP-A, EIP-B, EIP-C is above the limit requirement in SJ/T11363-2006.</p>						

The Ultimus workstation is designed to provide complete process control for precise, repeatable fluid dispensing.

Key features include

- All-digital, multi-function display with simultaneous readout of air pressure, time, vacuum, deposit shot count and time of day
- Unique air management reservoir and high-speed solenoid system for consistent, repeatable deposits
- Time increment adjustments as small as 0.0001 seconds for precise deposit control
- Workstation panels to hold a variety of useful accessories, including light, ergonomic syringe barrel holder, magnifier and more

First Steps

First: Place the dispenser in your work area. The Ultimus is equipped with “stay put” rubber pads. It can be placed on the benchtop or any flat surface.

Second: Connect to power and air supplies, and program the unit. For step-by-step setup instructions, see the Ultimus Quick Start Guide.

Third: Now is a good time to activate your Ten Year Warranty. Please register your warranty online at www.nordsonefd.com/warranty/dispensers/ten/ Or if you prefer, follow the instructions in the enclosed “Welcome” letter to contact your area Nordson EFD representative.

Cabinet size: 14.3 W x 18.1 H x 17.3 D cm (5.63 x 7.12 x 6.82")

Weight: 2.3 kg (5.0 lb)

Power adapter:

AC input: 100-240 VAC(+/-10%) ~, 50/60Hz, 0.6A

DC output: 24 VDC @ 1.04A

End-of-cycle feedback circuits: 5 to 24 VDC; 100mA maximum

Initiate circuits: Foot pedal, finger switch or 5 to 24 VDC signal

Cycle rate: Exceeds 600 cycles per minute

Time range: Programmable from 0.0001 to 999.9999 seconds

Ambient operating conditions:

Temperature: 5°C to 45°C (41°F to 113°F)

Humidity: 85% RH at 30°C non-condensing

Height above sea level: 2000 meters max (6,562 feet)

Meets or exceeds CE and CSA requirements

Ultimus I (7017041)

Air input: 80 to 100 psi (5.5 to 6.9 bar)

Air output: 0 to 100 psi (0 to 6.9 bar)

Ultimus II (7002003)

Air input: 80 to 100 psi (5.5 to 6.9 bar)

Air output: 0 to 15 psi (0 to 1.0 bar)

Ultimus III (7017068)

Air input: 80 to 100 psi (5.5 bar to 6.9 bar)

Air output: 0 to 5 psi (0 to 0.34 bar)

Note: Specifications and technical details are subject to change without prior notification.

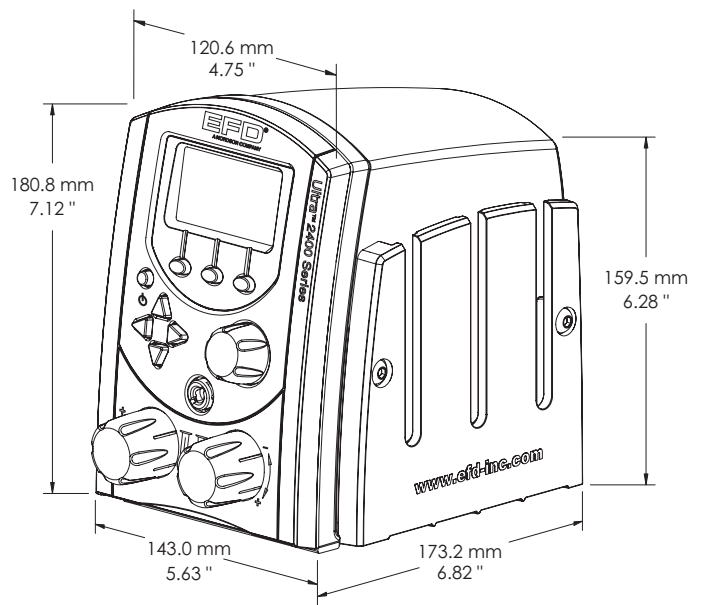

Features & Controls: Front Panel



Dispense Mode

When powered for the first time, the Ultimus Home screen displays in TIMED mode. Otherwise, it displays in the mode last used.

You can verify what mode you're in by checking the top left corner of the display screen. It will be TIMED, TEACH, STEADY or MEMORY.

- You can return to **TIMED** mode from **TEACH** or **STEADY** by pressing **TIMED** in the bottom right corner of the display.
- You can return to **TIMED** mode from **MEMORY** by pressing **MENU**, then selecting **TIMED**.

See the appropriate section below for details on each dispense mode.









Dispense Time

Dispense time, shown with an hourglass icon, displays from 000.0001 to 999.9999 seconds. Follow these steps to set the dispense time.

- Begin in **TIMED** mode.
- Press the left/right arrows to highlight the first number you want to change.
- Press the up/down arrows to set the time. Or if you prefer, you can also use the timer dial (top right knob) to set the time.
- Repeat as needed to adjust the other numbers in the dispense time row.



See the **Ultimus Icon Guide**, included with your dispensing system, if you are working in Chinese, Japanese, or Korean. Sample icons:

 (Timed)
  (Steady)
  (Teach)
  (Menu)
  (Select)
  (Home)

Air Pressure

Air pressure is displayed in psi. See page 20 to change the display of pressure from psi to bar or kPa. It is shown with the icon of an arrow pushing into a syringe barrel. Follow these steps to set air pressure.

- Pull the air pressure regulator knob out to unlock it (bottom left knob).
- Turn the knob clockwise to the desired pressure setting.
- To reduce pressure, turn the knob counterclockwise until the display reads a lower pressure than needed. Then increase the pressure until you reach the correct setting.
- Push the knob in to lock the pressure setting.



For Ultimius I, II and III units: Set plant air supply within 80 to 100 psi (5.5 to 6.9 bar).

Caution: A pressure regulator of 0 to 100 psi is intended to be provided before connecting unit to the air supply.

Vacuum

Vacuum is displayed in inH₂O (inches of water). See page 20 to change the display of vacuum from inH₂O to inHg, kPa, mmHg, or Torr. It is shown with the icon of an arrow pulling out of a syringe barrel. Follow these steps to set vacuum pressure.

- Pull the vacuum regulator knob out to unlock it (bottom right knob).
- Turn the knob clockwise to the desired setting. You can adjust the vacuum in increments of 0.1 inH₂O.
- Push the knob in to lock the vacuum setting.
- Caution: Use EFD filter/muffler #7016875 or wear adequate ear protection when operating the vacuum in close proximity for a prolonged period of time.



Clock

A real time clock is displayed in the top right corner. Follow these steps to set the clock.

- Press **MENU**.
- Press the down arrow to highlight **SET CLOCK**.
- Press **SELECT**.
- Press the left/right arrow to highlight the number to change.
- Press the up/down arrow to adjust the time. Or use the timer dial (top right knob) to adjust the time or toggle between AM (morning) and PM (afternoon/evening).
- Press **SAVE**. This saves the time and automatically returns you to the Home screen.



Power

Press the power button to turn the unit on. An EFD logo will briefly appear before the Home screen displays. The Ultimus will go into sleep mode when it's inactive for more than 90 minutes. Simply press any button or the foot pedal to reactivate the screen.

Menu

You can access the menu screen by pressing **MENU**. From here press the up/down and left/right arrows to select from a variety of screens, including:

TIMED	TEACH	MEMORY
CLEAR COUNT	UNITS OF PRESSURE	UNITS OF VACUUM
SECURITY	LANGUAGE	SAVE JOB
SET CLOCK	INFO	

See page 20 for details on various Menu functions.



Shot Count

The shot count is displayed in the top center section of the display screen. It displays the number of deposits that have been dispensed. Follow these steps to reset the shot count.

- Press **MENU**.
- Press the down arrow to highlight **CLEAR COUNT**.
- Press **SELECT**. This resets the shot count to 0 and automatically returns you to the Home screen.

Timed Mode

In **TIMED** mode, the Ultimus will dispense a single deposit each time you press the foot pedal or finger switch. Deposit size is based on dispense time and pressure settings shown on the display.

Steady Mode

In **STEADY** mode you can dispense for as long as you press the foot pedal or finger switch. From **TIMED** mode, press **STEADY**. This toggles the display so that the top left corner is now selected for **STEADY** mode. See Initial Test Procedures, page 16, for more details on **STEADY** mode.

Teach Mode

In **TEACH** mode you can “teach” the deposit based on physical size. Begin in the Home screen for **TIMED** mode. Press **TEACH**. This toggles the display so that the top left corner is now selected for **TEACH** mode. See Initial Test Procedures, page 16, for more details on **TEACH** mode.

Output Air Port

The Ultimus features two output air ports. You can connect the Optimum™ adapter assembly to the port on the front panel or the back panel, whichever is most convenient.

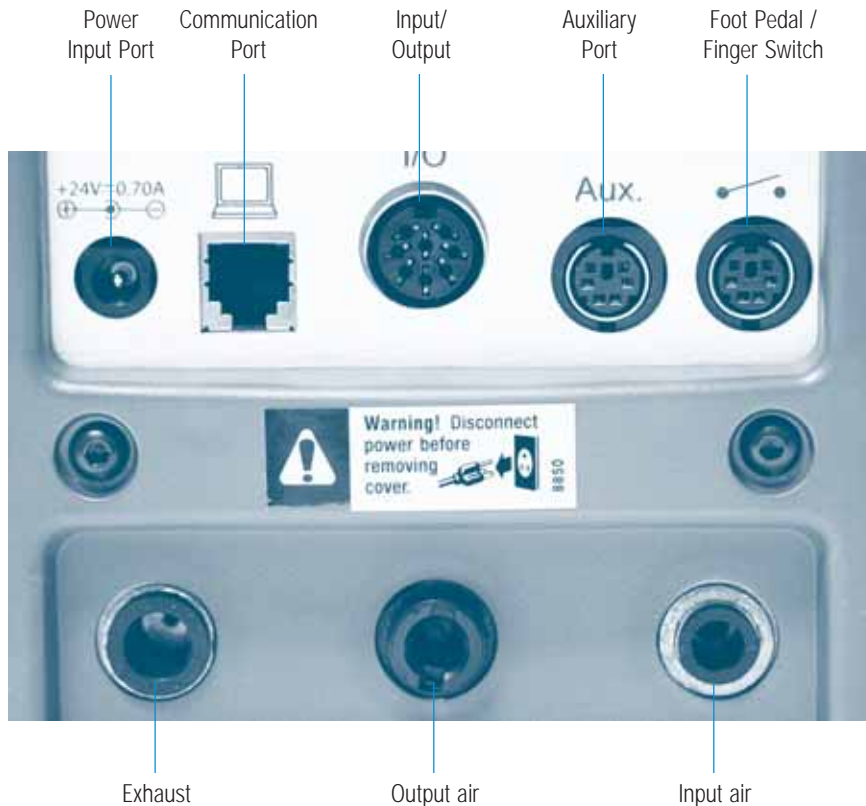

Power Input Port

The power input port is located at the top left corner of the Ultimus. The Ultimus power pack automatically adjusts for 100 to 240 VAC.

Use only the universal power pack provided with the Ultimus workstation. The unit is shipped with four power plugs (one USA and three international plugs) and a 5.9 ft (1800 mm) length power cord.

- Connect the DC plug from the cord into the Ultimus power input port.
- Connect the power cord into your local power source.

Communication Port

The Ultimus communication port, located on the top row of ports, is for EFD use only.

Input/Output 8 Pin Interface Connector

Input/output features are used when the Ultimus is interfaced with external control circuits. The 8 pin connector is located on the top row of ports. See page 22 for details.

- An End-of-Cycle signal, in the form of a solid-state switch, closes upon completion of the dispense cycle.

Auxiliary Port

The auxiliary port, a 6 pin mini DIN connection, is located on the top row of ports. It is designed to power the Ultimius accessories such as the workstation lamp. The auxiliary port is interchangeable with the foot pedal / finger switch port.

Foot Pedal / Finger Switch Port

The switch port, a 6 pin mini DIN connection, is located on the top right corner of the Ultimius. It is used to connect the foot pedal or finger switch that activates the dispense cycle. The switch port is interchangeable with the auxiliary port, described above. Be sure to align the foot pedal or finger switch cord connector so that arrow on the connector is on top.

Exhaust Port

The exhaust port is the larger 8 mm pneumatic fitting located at the bottom left corner of the Ultimius workstation.

- If needed, you can connect a cleanroom filter muffler to filter output air to meet Fed 209-B (0.5 micron particulates). Specify #7017049.
- Caution: Use EFD filter/muffler #7016875 or wear adequate ear protection when operating the vacuum in close proximity for a prolonged period of time.

Air Output Port

The Ultimius features two air output ports to provide regulated air pressure to the syringe barrel. Both ports have quick-connect fittings and are interchangeable, sharing the same air source.

- You can connect to the port on the front panel or the back panel, whichever is most convenient.
- On the back panel, the air output is the center port on the bottom row.
- Push in the black quick-connect from the EFD adapter assembly to the air output port and twist to lock. Note: air does not flow through the port until a quick-connect is installed.

Air Input Port

The air input port is the smaller pneumatic fitting (6 mm) located at the bottom right corner of the Ultimius workstation.

- Push one end of the air input hose into the input fitting on the back of the Ultimius. An 8 ft (2.4 m) air hose is provided.
- Connect the other end of the air input hose to your plant air supply. A standard 1/4-inch NPT fitting is included with your unit.

Note: clean, dry filtered factory air is required to meet warranty. If your air supply is not filtered, order the five-micron filter regulator specify #7002002.

Warning! Bottled nitrogen can be used. If high pressure bottled air or nitrogen is used, a high pressure regulator must be installed on the bottle and set at 100 psi (6.9 bar) maximum. In this instance, the #7002002 filter regulator is not required.

Caution: A pressure regulator of 0 to 100 PSI is intended to be provided before connecting unit to the air supply.

Caution: Do not completely fill syringe barrels. The optimum fill is a maximum 2/3 of the barrel capacity and 1/2 of the barrel capacity when using the EFD blue LV Barrier™ piston.

For best results, we strongly recommend that you use a piston as part of your dispensing system. The white EFD SmoothFlow™ piston is appropriate for most fluids and has several advantages.

- First, vacuum adjustment is less sensitive.
- Second, the piston prevents fumes from the fluid being exhausted into the work environment.
- Third, the piston prevents fluid backflow into the dispenser if the syringe barrel is inadvertently turned upside down.
- Fourth, the piston makes it easy and safe to change tips without dripping.

For watery solvents and cyanoacrylates, request the blue EFD LV Barrier piston, available in 3cc, 10cc and 30cc sizes. If you are dispensing an RTV silicone and find that the piston bounces and causes stringing, request the EFD orange, flat wall piston.

Remember
For best results, EFD strongly recommends the use of a piston as part of your dispensing system.



SmoothFlow piston prevents fluid backflow.



Fumes cannot escape. No air gap when using the SmoothFlow piston.

If you choose to not use a piston when dispensing thin fluids, remember these important points.

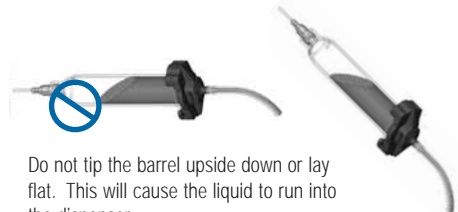

Do not tip the barrel upside down or lay flat. This will cause the liquid to run into the dispenser.

Open When changing tips or attaching a tip cap, snap the safety clip completely closed to prevent any dripping or bubbling.



Closed

Filling procedure for pourable low and medium viscosity fluids

If the fluid you are dispensing is pourable, take the syringe barrel, twist on an orange tip cap and pour your fluid in. Insert a white SmoothFlow piston and carefully press down until it contacts the fluid. The syringe barrel is now ready for use.

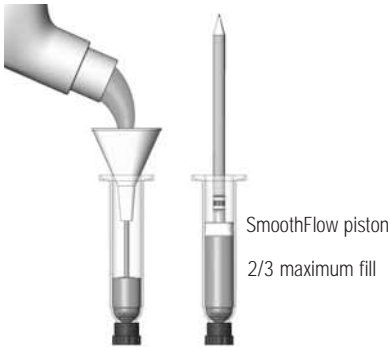

Filling procedure for thick fluids

If your fluid is thick or non-leveling, you can spoon it into the syringe barrel with a spatula. Or, if the fluid comes packed in a 1/10 gallon (300 ml) cartridge, try loading the barrel with a caulking gun. Then, press the SmoothFlow piston to move the fluid to the bottom of the syringe barrel and remove trapped air.

Trapped air in thick fluids can lead to drooling and oozing. Also, repetitive air cycles can bore tunnels through non-leveling fluids, causing spitting and inconsistent deposits. The SmoothFlow piston eliminates these problems. It prevents tunneling by providing a barrier to the pulsed-air cycles. And it prevents oozing by responding to the pressure of trapped air with a slight suck-back movement after the dispense cycle.

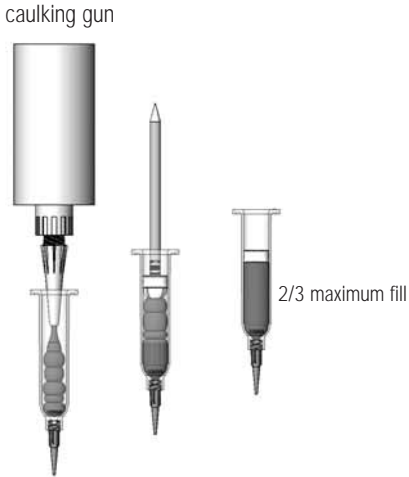

Filling procedure for watery fluids and vacuum control

The Ultimus vacuum regulator allows low viscosity fluids, even water, to be consistently dispensed without dripping between cycles. A vacuum is exerted above the fluid in the barrel to prevent dripping. For medium to high viscosity fluids, the recommended vacuum setting is 0.0.

If you are dispensing watery solvents, cyanoacrylates or anaerobics, request the blue LV Barrier piston and follow these steps to fill the syringe barrel and set the vacuum control.

1. Twist a blue tip cap onto an empty syringe barrel and pour your fluid in. Insert the blue LV Barrier piston. Allow an air gap between piston and fluid as shown. (If you are using the SmoothFlow piston, push the white piston down until it comes in contact with the fluid.)
2. Attach the syringe to the EFD adapter assembly.
3. Snap the safety clip tightly closed to prevent any dripping.
4. Remove the tip cap and attach a precision dispense tip.
5. Set air pressure at 2 psi (0.1 bar).
6. From **TIMED** mode, press **STEADY**.
7. With the syringe barrel pointing down over a container, unsnap the safety clip. Press and hold the foot pedal or finger switch to fill the tip.
8. As a drop begins to form at the end of the tip, slowly turn the vacuum regulator knob clockwise to stop the drip. Wipe the tip and adjust vacuum as necessary.
9. Return to **TIMED** mode.
10. Rest the tip on the Dot Standards sheet. Press the foot pedal and release. Check the dot size. Increase or decrease by adjusting pressure or time as needed.

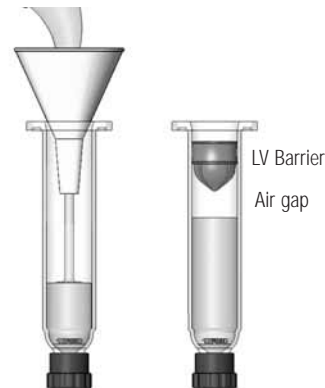

Caution: Use EFD filter/muffler #7016875 or wear adequate ear protection when operating the vacuum in close proximity for a prolonged period of time.

Note: For best results when dispensing watery-thin fluids, Nordson EFD recommends the use of the Vacuum Suck-Back Filter Trap #7017115. This is guaranteed to prevent fluid from being sucked back into the dispenser. See page 26 for a sample drawing, or call EFD or email info@nordsonefd.com for details.

Syringe Barrel Loading Alternatives

Nordson EFD offers productive alternatives to traditional syringe barrel loading methods. Here are a few suggestions that can help keep your work area clean, save time and reduce the chance of entrapped air in the fluid.

1. You could use the #7022445 Atlas™ Filling System. Pack the fluid into the 12 ounce cartridge as shown. Then place the pre-filled cartridge into the barrel loader. Using air pressure, the barrel loader fills the syringe barrel (with a piston installed) from the bottom up.

If the fluid comes packed in a 1/10 gallon (300 ml) caulking type cartridge, use the EFD #7022452 filling system.

For fast, volumetric filling, #7022068 Atlas Filling System, is an accurate, easy and fast system to fill syringe barrels.

2. If you receive frozen epoxies or other fluids in medical type syringes with a manual plunger, request the EFD luer-to-luer fitting #7016862 to transfer the material.

Please contact an EFD fluid application specialist for additional assistance.

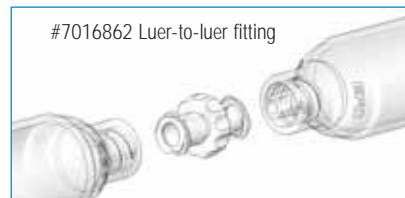
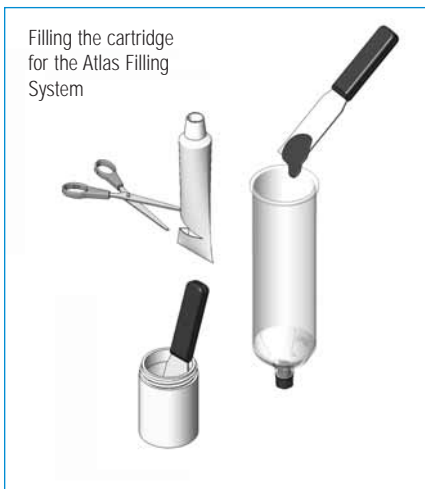
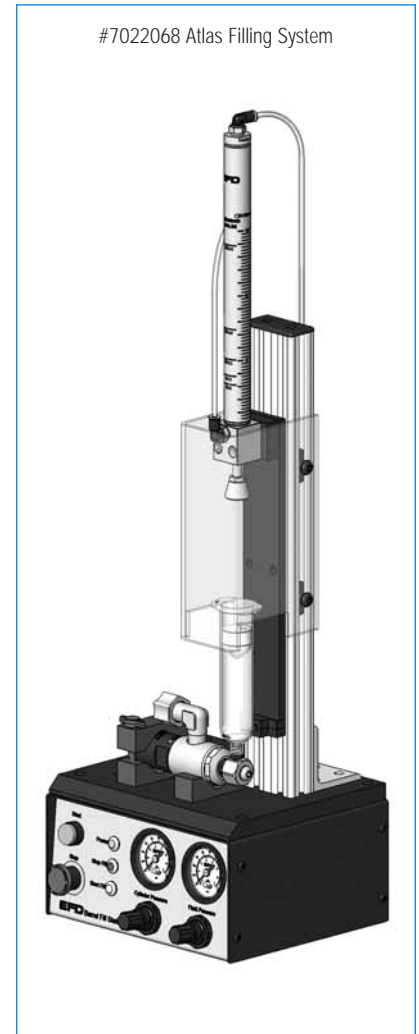
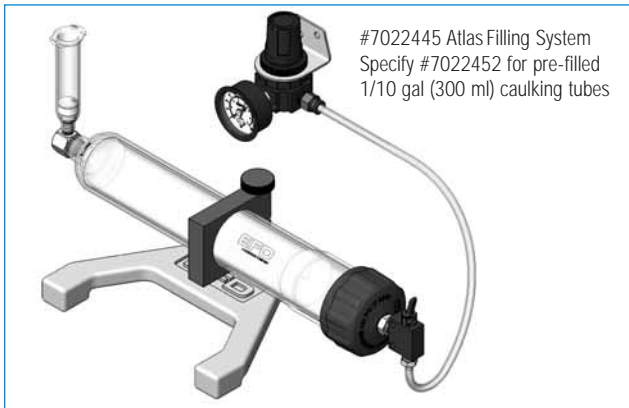

Deposit size is controlled by time, pressure and tip size.

Please follow these instructions to test each function. Use the convenient Dot Standards sheet included in your dispensing system kit.

Setup for Testing

1. Attach an EFD syringe barrel filled with your assembly fluid to the adapter assembly as shown.
2. Keep the vacuum set at 0.0 during initial testing. (If you are dispensing a watery fluid, see Vacuum Control, page 14).
3. Replace the blue tip cap with an EFD precision dispense tip.
4. Slide the syringe barrel into the hand grip. Snap in place.
5. Run through the following tests to demonstrate the ease at which deposit sizes can be established using the various dispense modes.

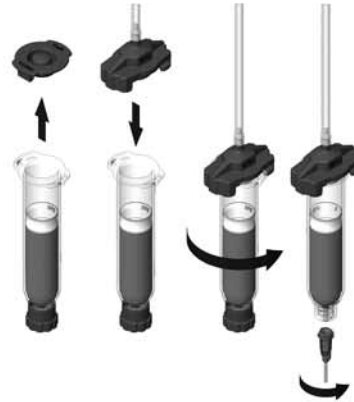

Testing in Steady Mode

- Select **STEADY** mode.
- Pull the air pressure regulator knob out until it clicks into the unlocked position. Start with pressure set to 0 psi (0.0 bar).
- Press and hold the foot pedal or finger switch.
- **Slowly**, turn the pressure knob clockwise until your fluid begins to dispense out of the tip in a controlled flow (not too fast, not too slow).
- Push the air pressure knob in to lock setting.



Remember - always bring the tip in contact with the work surface at the illustrated angle. After the tip is in position, press the foot pedal. Release pedal and remove tip by lifting straight up.



Correct angle for consistent deposits.

Testing in Timed Mode

- Follow steps in “Testing in Steady Mode” to purge your dispensing tip with fluid.
- Change to **TIMED** mode.
- Set time to 000.0250 seconds.
- Rest the dispense tip on the Dot Standards sheet.
- Press the foot pedal (or finger switch) to activate the dispense cycle. **Note:** the pedal only needs to be pressed for a moment. The complete time will run once you activate the dispense cycle.
- **Changing the time changes the deposit size.** If your dot is too small, increase the dispense time to increase the deposit size. If your dot is too large, decrease the dispense time to decrease your deposit size.

Testing in Teach Mode

- Follow steps in “Testing in Steady Mode” to purge your dispensing tip with fluid.
- Change to **TEACH** mode.
- Rest the dispense tip on the Dot Standards sheet.
- Press the foot pedal to establish your dot size. Tapping the foot pedal repeatedly will have a cumulative effect on the dot size and dispense time.
- Continue to press the foot pedal until you achieve the correct deposit size.
- Save the dispense time setting you just created by pressing **SAVE**. This automatically exits **TEACH** mode and returns you to **TIMED** mode.
- If needed, press **CLEAR** to start over.

If you have any questions at this point, please call us now.

In the USA, call 800-556-3484 between 8:30 a.m. and 5:30 p.m. Eastern time.

In Europe, call +44 (0) 1582 666334.

In Asia, call +86 (21) 3866 9006.

In all other areas, call your authorized EFD distributor or +1-401-431-7000.

The Ultimus dispensing workstation allows you to store the dispense time, pressure and vacuum settings for up to 16 different job programs. Programs are saved even with power removed and will remain in storage unless changed or erased intentionally.

Job programs are identified as Memory 1 through Memory 16.

Note: Dispense time is automatically adjusted when you select an individual job program. Settings for pressure and vacuum are stored and can be displayed but you need to manually adjust the pressure and vacuum regulator knobs to match the stored settings for these values.

To Save a Job Program

1. From **TIMED** or **TEACH** mode, set the dispense time, air pressure and vacuum settings to create a correct deposit size. When you are in **TEACH** mode, press **SAVE** after you create your settings, then return to **TIMED** mode.
2. Press **MENU**. Use the up/down arrows to highlight **SAVE JOB**. Press **SELECT**.
3. Use the up/down arrows to select the correct job program in which to save these settings (example, Memory 1 or Memory 2). Remember: to prevent accidental data loss, review the contents of each job program before selecting and storing a new job into memory.
4. Press **SAVE**. This automatically saves the settings in the job program and returns you to the Home screen.
5. Press the foot pedal or finger switch to activate the dispense cycle. The Ultimus workstation will make the deposit based on the settings in the selected job program.

To Work in a Saved Job Program

1. Press **MENU**. Use the up/down arrows to highlight **MEMORY**. Press **SELECT**.
2. Use the up/down arrows to scroll through the individual jobs until you reach the correct Memory number.
3. Press and hold **SETTINGS** to see the stored pressure and vacuum settings for the job. Remember: Dispense time automatically adjusts when you select a job program. Releasing the Settings button displays the current values for pressure and vacuum, not the stored values. To retrieve the stored values, manually adjust air pressure and vacuum, based on the pressure and vacuum shown when you press Settings.
4. Press the foot pedal or finger switch to activate the dispense cycle. The Ultimus will automatically make the deposit based on the settings in the selected job program.
5. To escape from Memory, press **MENU**. Then press **TIMED** to return to the Home screen. At this point, you are still in the current memory setting for the previous job program, but you are free to change time, pressure and vacuum without impacting the stored settings in memory.

To Edit or Clear a Saved Job

Follow these steps to make changes to an existing job.

1. Press **MENU**. Use the up/down arrows to highlight **MEMORY**. Press **SELECT**.
2. Use the up/down arrows to select the correct job program to edit (Memory 1, Memory 2, etc.).
3. If you need to review the stored values for pressure and vacuum, press and hold **SETTINGS**. You can adjust the pressure and vacuum from this screen, or you can make adjustments from **TIMED** mode. However, note: you can only adjust the dispense time setting from the **TIMED** mode screen.
4. Press **MENU** again.
5. Press **TIMED** to return to **TIMED** mode in the selected program.
6. Adjust the settings for dispense time, air pressure and vacuum as needed to achieve the correct deposit size.
7. Press **MENU**.
8. Use the up/down arrows to highlight **SAVE JOB**. Press **SELECT**.
9. Use the up/down arrows to again select the correct job program.
10. Press **SAVE**. This automatically saves the changed settings and returns you to the Home screen.

Note: to clear all settings in a specific job program, simply set the time, pressure and vacuum to 0 in step 6 and follow the other steps as noted.

You can access the menu screen by pressing **MENU**. From here press the up/down and left/right arrows to select from a variety of screens.

Timed/Teach mode

See pages 8-10 for details on the Ultimus dispense modes.

Memory/Save Job

See pages 18-19 for details on Memory and Save Job functions.

Clear Count

See page 10 for details on Shot Count and Clear Count functions.

Units of Pressure/Units of Vacuum

You can change the screen display of air pressure units from psi to bar or kPa, or for vacuum units from inH₂O to inHg, kPa, mmHg, or Torr. Follow these steps:

- Press **MENU**.
- Press the up/down arrow to highlight **UNITS OF PRESSURE** or **UNITS OF VACUUM**, then press **SELECT**.
- Press the up/down arrow to highlight the appropriate pressure or vacuum display option.
- Press **SELECT** again to make the change. This automatically returns you to the Home screen.

Language

You can change the screen display from English to another language. Follow these steps.

- Press **MENU**.
- Press the up/down arrow to highlight **LANGUAGE**, then press **SELECT**.
- Press the up/down arrow to highlight the appropriate option.
- Press **SELECT** again to make the change. This automatically returns you to the Home screen.

Info

The Info screen displays the Ultimus workstation's serial number, model number and contact web site for customer service. To view **INFO**, press **MENU**, use the up/down arrow to highlight **INFO**, then press **SELECT**.

Security Code

You can set a 4-digit password to prevent job changes by unauthorized users. This password locks out the ability to change dispense time, clear the shot count and modify settings in Memory. The password is required to access the Security screen. Unauthorized users get a Password Error message if they attempt to enter an invalid password.

To select the functions to password protect

- Press **MENU**.
- Press the up/down arrow to highlight **SECURITY**, then press **SELECT**.
- For first time users, enter 0000 as the current password and press **ENTER** (0000 is the default setting).
- Press the up/down arrows to highlight the functions to protect (Memory, Shot Count and Time).
- Press **SELECT** to toggle between adding or deleting a checkmark next to each function. To **protect** the function from unauthorized changes, add the checkmark. To **disable** the password and allow any user to change settings, delete the checkmark.
- Press **HOME** to return to the Home screen.

To change the password

- Press **MENU**.
- Press the up/down arrow to highlight **SECURITY**, then press **SELECT**.
- For first time users, enter 0000 as the current password and press **ENTER** (0000 is the default setting).
- Press **PASSWORD**.
- Press the left/right arrows to highlight the first number.
- Press the up/down arrows to set the number. Or if you prefer, you can also use the timer dial.
- Repeat to adjust the other numbers in the 4-digit code.
- Press **ENTER**. This puts you in the Security screen and automatically stores the new password.
- Press **HOME** to return to the Home screen.

Voltage Initiate Circuit

The Ultimius workstation may be initiated with a 5 to 24 VDC signal across pins 1 and 2. The signal can be momentary (no less than 0.01 seconds) or maintained. A new cycle will begin once power is removed and then applied again.

Mechanical Contact Initiate

The Ultimius can be initiated via the closure of mechanical contacts such as a relay or switch using pins 7 and 8. Closure of the contacts can be momentary (no less than 0.01 seconds) or maintained. A new cycle will begin once the contacts are opened and then closed again.

End-of-Cycle Feedback Circuit

Upon completion of a dispense cycle, a solid state switch closes and remains closed until the next dispense cycle. Pins 3 and 4 of this circuit can be used to signal back to a host computer, start another device in sequence or initiate other operations that need to be tied into the completion of the dispense cycle.

The circuit is designed to operate between 5 to 24 VDC, 100mA maximum.

Pin Function

1. Voltage initiate +, 5-24 VDC (35mA maximum)
2. Voltage initiate -
3. End-of-cycle feedback output +, 5-24 VDC (100mA maximum)
4. End-of-cycle feedback output -
5. 24 VDC supply + (100mA maximum)
6. 24 VDC supply -
7. Contact closure +, 24 VDC @ 20mA
8. Contact closure -

Note: An 8 pin male connector assembly is available. Specify #7017143.

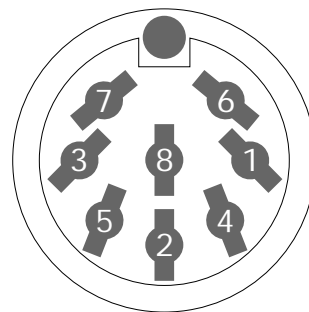

Back panel I/O pin diagram

Item	Part #	Description
1	7002004	Tubing - 6 mm OD urethane, blue*
2	7017060	Air manifold 100 psi (6.9 bar)
	7017062	Air manifold 15 psi (1.03 bar)
	7017064	Air manifold 5 psi (0.34 bar)
3	7017071	Face plate
4	70170737	Rotary dial
5	7017075	Chassis
6	7017076	Cover
7	7017078	Work panel - left
8	7017080	Work panel - right
9	7017082	Rubber strip - front
10	7017084	Rubber strip - rear
11	7017087	LCD protective lens
12	7017088	Key pad
13	7017090	Communication cable
14	7017092	Circular foot pedal*
15	7017094	Front cover

Item	Part #	Description
16	7017095	Display board assembly
17	7017097	I/O board assembly
18	7017101	Barrel holder sleeve
19	7017104	Barrel holder
20	7017133	Barrel hand grip
21	7015199	Kit, 25w universal power supply*
22	7023528	Screw – M3 x 6 mm, buttonhead
23	7023533	Screw – M4 x 12 mm, buttonhead
24	7023542	Screw – M4 x 8 mm, buttonhead
25	7023572	Screw – M6 x 20 mm, buttonhead
26	7023574	Screw – M6 x 25 mm, buttonhead
27	7023577	M6 x 8 mm T-Slot nut
28	7017128	Adapter hose holder
	7017157	Washer
29	7022198	Fitting – 1/4-inch NPT x 6 mm*

* Not shown

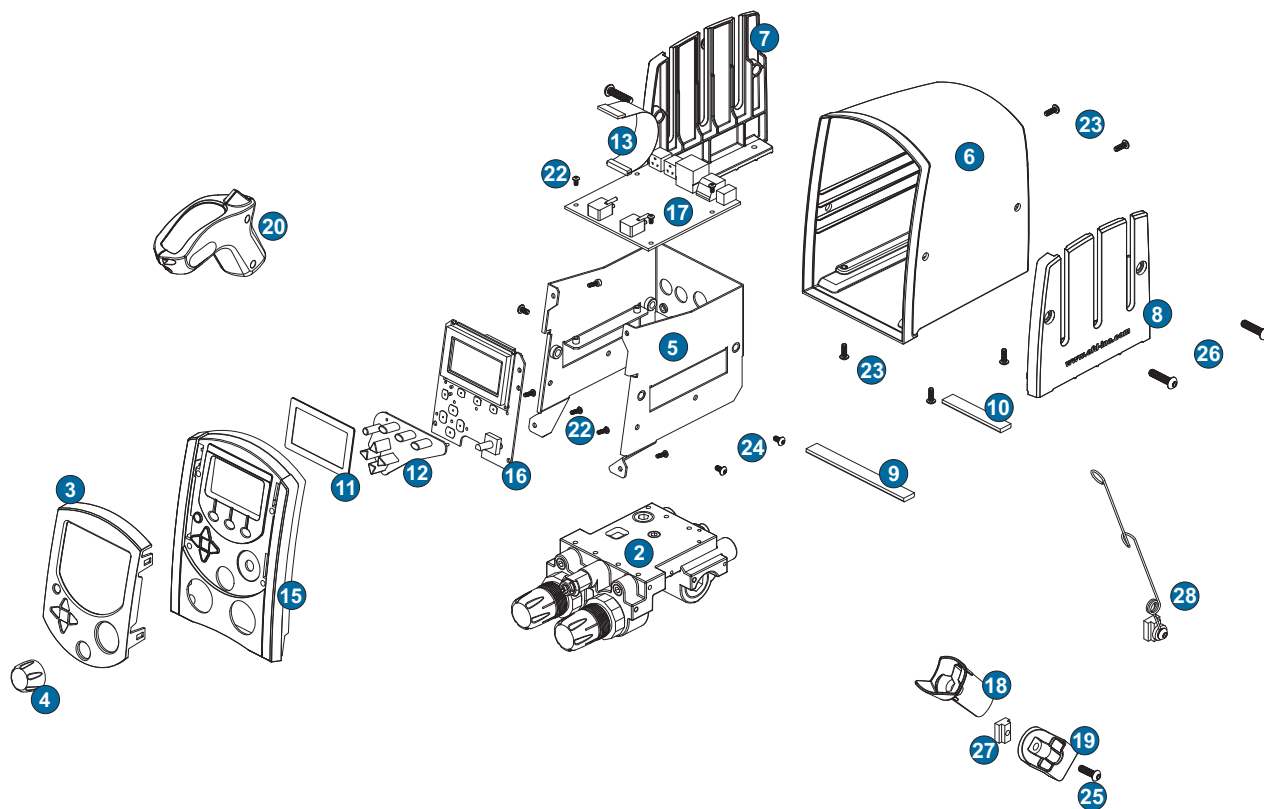

If you encounter a problem that you cannot readily solve, call EFD.

Trouble	Possible cause and correction
No power	Be sure that there is power at the wall receptacle. Note: there is a resettable internal fuse on the Ultimus unit, so there is no need to ever replace the fuse. Allow unit to cool down, and it will reset itself as necessary.
Auxiliary output is not functioning	Insure that the load does not exceed 100mA. If the output has been overloaded, remove the load and allow circuit to cool. The circuit will reset itself.
Inconsistent dots	<ol style="list-style-type: none"> 1. Check dispensing tip, syringe barrel and material for possible clogging. 2. Check dispenser air pressure display to be sure air pressure is not varying. If needed, use the filter regulator #7002002. 3. Air bubbles in the material can cause inconsistency. For best results, remove all air bubbles.
Timer seems inoperative	<p>Check to be sure you are not in STEADY mode. The upper left corner of the display should read TIMED or MEMORY.</p> <p>Note: The EFD timer is very reliable. Any failure will be total, so that no inconsistency is possible. Most questions regarding the timer are resolved by simply turning STEADY mode off.</p>
Material suck-back	<ol style="list-style-type: none"> 1. Use a SmoothFlow piston or LV Barrier to prevent material being drawn into the dispenser. 2. Another option is the order the vacuum suck-back filter trap accessory, which is guaranteed to prevent fluid for leaking into the dispenser. Order part #7017115. 3. If suck-back occurs, attach an empty barrel, put in STEADY mode, place the barrel in a cup, then press the foot pedal to expel the fluid. 4. If the problem cannot be corrected, contact an EFD Fluid Application Specialist for assistance. <p>Dispensers can be returned to EFD for repair.</p>
Display backlight is off	The Ultimus workstation is in sleep/power save mode. Press any button or press the foot pedal to reactivate.
Voltage initiate does not function	Check to see that the voltage is between 5 and 24 VDC and the current does not exceed 100mA.
Air leaking from exhaust port	Air from the exhaust is normal when vacuum is used. If vacuum is completely off and you still hear air, make sure plant air supply to your unit is set to within 80 to 100 psi (5.5 to 6.9 bar).

Helpful Hints

1. There are three core variables to the Ultimus dispensing workstation: time, pressure and vacuum. Adjust just one of these at a time, in small increments, to achieve the correct deposit.
2. Another variable is tip size. Choose the right tip for the deposit type. Remember, smaller tips require more pressure and more time. Try different tips without changing the time or pressure settings and observe the results.
3. Tapered tips reduce the amount of air pressure needed to dispense thick materials. They also help prevent drooling at the end of a dispense cycle.
4. To ensure smooth fluid flow and to make consistent deposits, keep the dispense tip at a 45° angle to the work surface.
5. Use EFD SmoothFlow pistons to make barrel loading, dispensing and handling cleaner, safer and more accurate. Caution: If you dispense watery fluids and choose not to use EFD pistons, do not increase vacuum pressure rapidly and do not tip the barrel. Vacuum may pull fluid into the adapter hose; or if the syringe barrel is tipped, fluid may flow back into the dispenser.
6. Always use new EFD syringe barrels and tips. Carefully dispose of after use. This procedure ensures maximum cleanliness, prevents contamination and provides proper safety.
7. Do not completely fill the syringe barrel. For most fluids, optimum fill is a maximum 2/3 of the barrel capacity. For cyanoacrylates or watery fluids, optimum fill is 1/2 of the barrel capacity.

Suggestions on Settings

1. To reduce air pressure, turn the knob counterclockwise until the display reads at a lower-than-needed pressure setting. Then turn clockwise to increase pressure until you reach the correct setting.
2. Avoid high pressure settings with very short time settings (example: 80 psi; 5.5 bar at less than 0.01 seconds). The ideal setup matches air pressure and tip size to create a “workable” flow rate – no splashing, but not too slow either – with a time setting that is not extremely low.
3. With any fluid, always give the air pressure time to do its job. Moderate time and pressure provides the best results since dispensing pressure remains at its peak for a longer period of time.
4. Longer dispense time settings generally provide the highest accuracy. However, in the interest of cost-effective production, do not use excessively long dispense time settings. Experiment to find what works best for your application.

Choose from this list of optional productivity tools to maximize your Ultimus dispensing workstation.

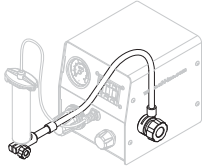

Flexible arm syringe barrel holder

This flexible arm mounts to the work panels and can be adjusted to multiple heights and angles. Specify #7017105.

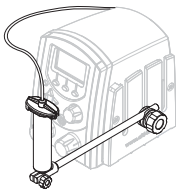

Stiff arm barrel holder

This stiff arm mounts to the work panels and securely holds the syringe barrel in a fixed position. Specify #7017113.

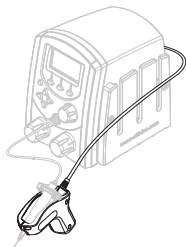

Barrel hand grip with finger switch and light

Hand grip with innovative finger switch that is activated by a built-in touch sensor. Incorporates a high-beam penlight to illuminate the dispensing target area. Fits all sizes of syringe barrels from 3cc to 55cc. Specify #7017131.

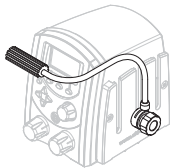

Workstation lamp

Helpful work lamp is mounted on a flexible arm, can be adjusted to multiple positions and provides targeted lighting to help operators work with greater accuracy and comfort. Specify #7017122.

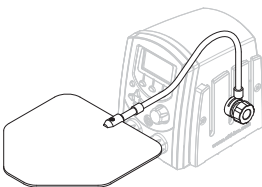

Safety shield

Large, acrylic safety shield is mounted on a flexible arm and can be adjusted to multiple positions. Provides splash guard protection in areas where adhesives and toxic fluids are used. Specify #7017119.

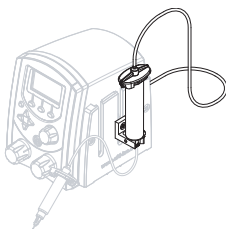

Vacuum suck-back filter trap

Unique design is guaranteed to prevent fluid from being sucked back into the dispenser and ensures error-free operation. Holds up to 30cc of fluid. Specify #7017115.

Production extension shelf

Handy extension shelf allows you to stack dispensers vertically for multiple dispensing applications, maximizes limited bench space and provides a flat work surface for other tools. Specify #7017138.

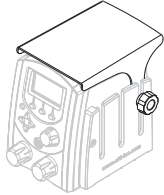

Magnifying lens

1.7x magnification ensures more accurate deposit placement, improves repeatability and reduces risk of operator strain. Specify #7017135.

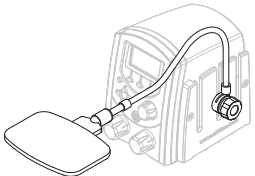

I/O connector assembly

Allows easy connection to the Ultimius dispenser for external control. One end has an 8 pin male DIN connector; opposite end connects to external devices. Specify #7017143.

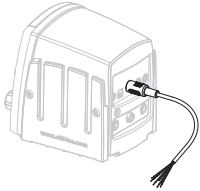

Vacuum pickup pen system

All-in-one vacuum generator and pen system for picking up and placing small parts. For use with any air-powered dispenser. Specify #7017167.

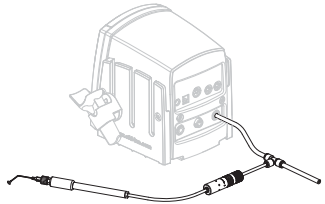

Five-micron regulator

Required for production areas where clean, dry filtered factory air is not available, or to stabilize plant air supply for more consistent deposits. Specify #7002002.

For dispensing cyanoacrylates, order the regulator with a coalescing filter that removes liquid aerosols from the air supply. Specify #7016548.

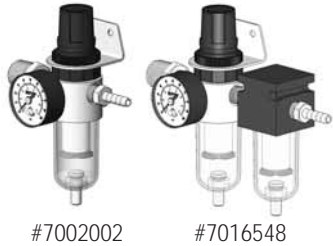

Cleanroom filter muffler

Attaches to the Ultimius exhaust port and filters output air to meet Fed 209-B (0.5 micron particulates). Designed for use in cleanroom environments. Specify #7017049.

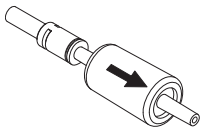

Nordson EFD Ten Year No-Fault Warranty

EFD dispensers are warranted to the original end user for 10 years from date of purchase.

Within the period of this warranty, EFD will repair or replace free of charge any defective part, regardless of fault, on return of the part, or the complete dispenser, prepaid to the factory.

In no event shall any liability or obligation of EFD arising from this warranty exceed the purchase price of the equipment. Before using, user shall determine the suitability of the product for his intended use, and user assumes all risk and liability whatsoever in connection therewith. This warranty is valid only when clean, dry, filtered air is used.

EFD makes no warranty whatsoever of merchantability or fitness for a particular purpose. In no event shall EFD be liable for incidental or consequential damages.

For Nordson EFD LLC sales and service in over 30 countries, contact Nordson EFD or go to www.nordsonefd.com

East Providence, RI USA
USA & Canada: 800.556.3484;
+1.401.431.7000
info@nordsonefd.com

Dunstable, Bedfordshire, UK
0800 585733; +44 (0) 1582 666334
Ireland 00800 8272 9444
europaenordsonefd.com

China: +86 (21) 3866 9006
china@nordsonefd.com

Singapore: +65 6796 9522
sin-mal@nordsonefd.com

The Wave Design is a trademark of Nordson Corporation
©2011 Nordson Corporation 2400-MAN-01 (7017042) v042711 Rev-02



This equipment is regulated by the European Union under WEEE Directive (2002/96/EC). See www.nordsonefd.com for information about how to properly dispose of this equipment.

